

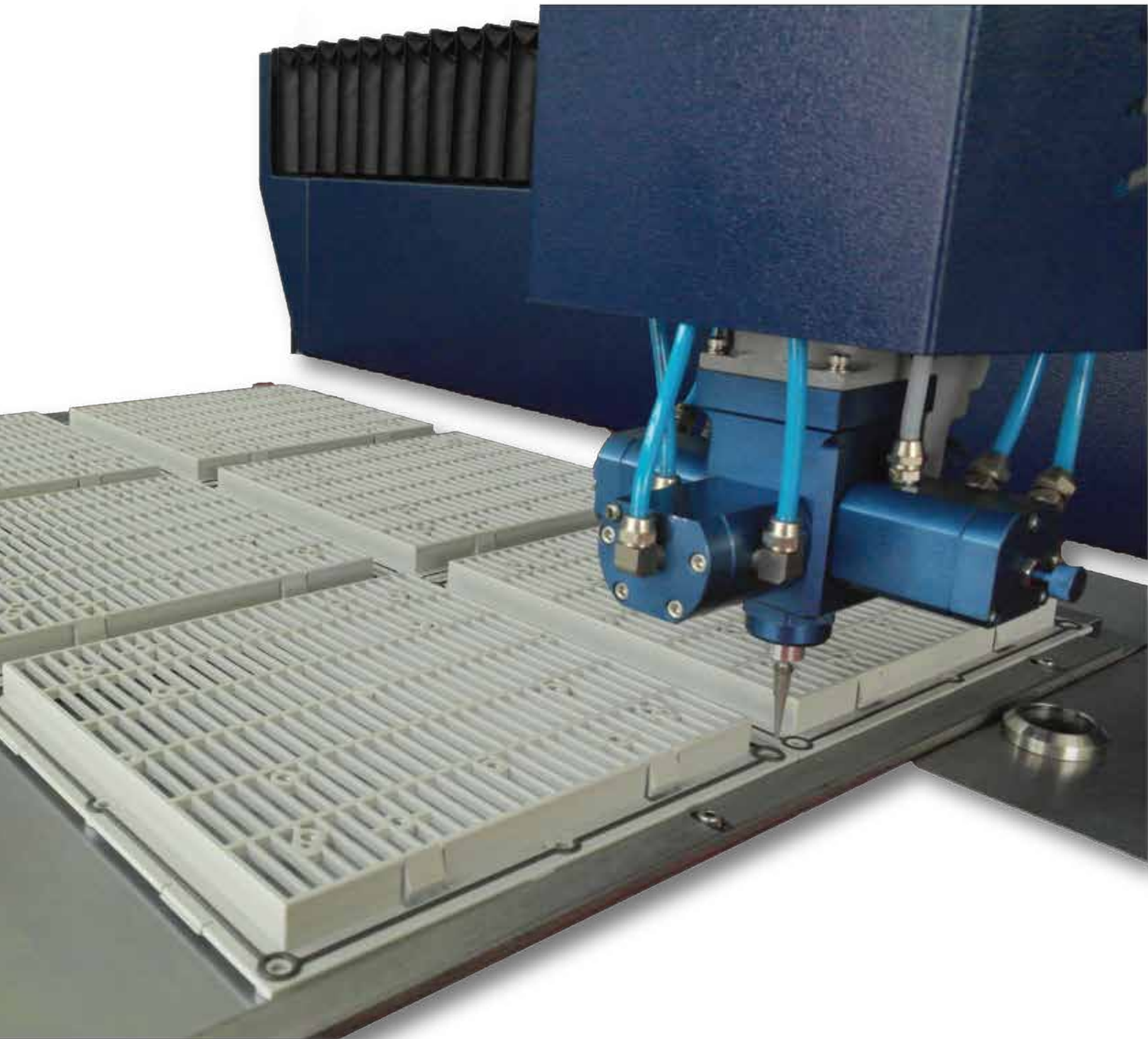

**IRC AUTOMATION (M) SDN BHD**  
(1195989-D)



**AUTO SEAL GLUING MACHINE**  
SOLUTION FOR ENCLOSURE SEALING

IRC AUTOMATION (M) SDN BHD is specialized in research, design, manufacturing, sales and services of the auto dispensing machines.

We possess the best research team, skillful manufacturing team, widely sales network and great after sales service system with strong technical background continuously increasing product quality to serve our clients better.



Compared with the traditional sealing process, the foam sealing uses the form-in-place method to reduce costs, replace the manual hand-pasting, create perfect jointing, good adhesion, strong resilience, dust-proof and waterproof gasket.

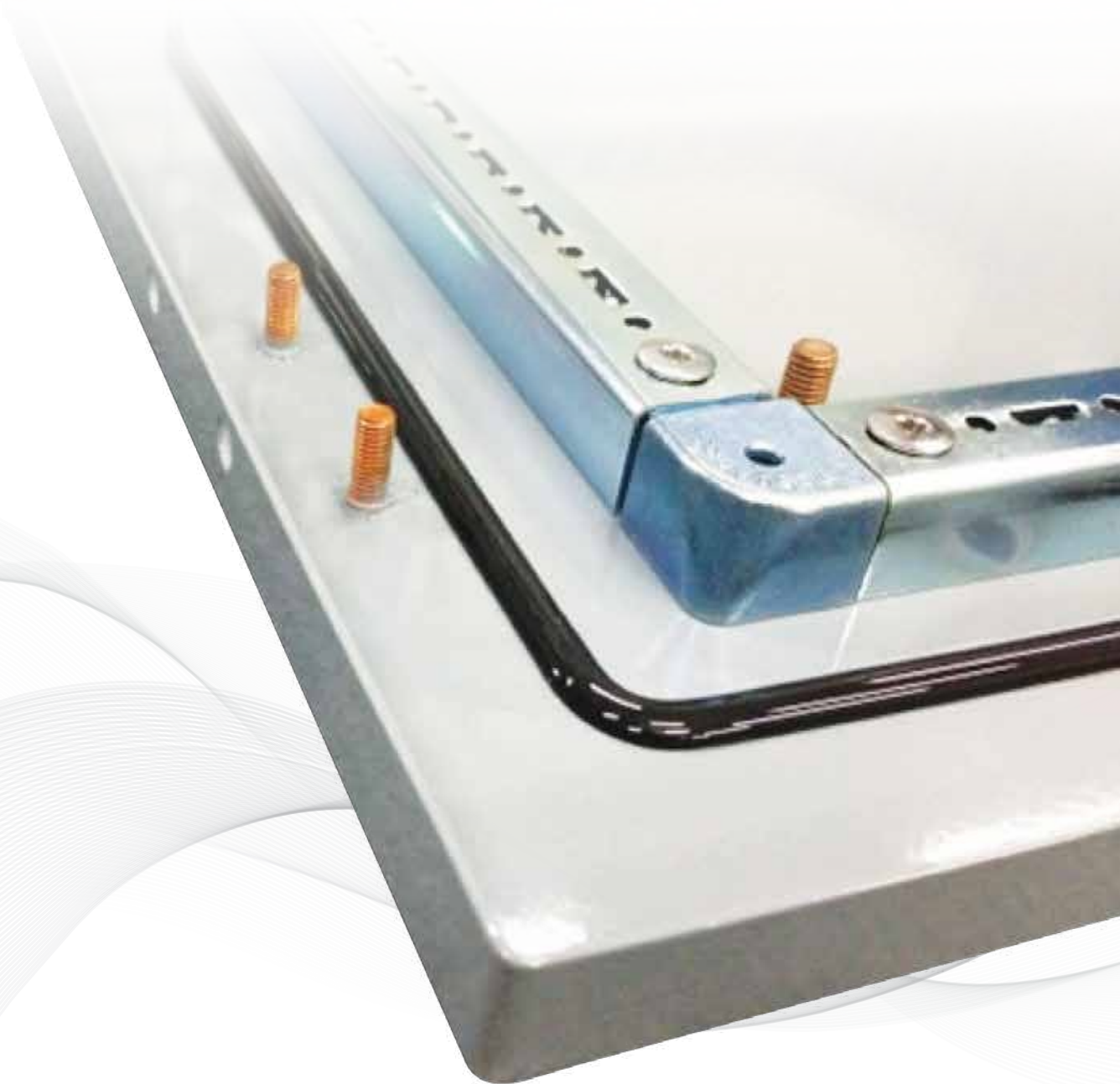



MODEL	MACHINE DENOMINATION	WORKING AREA	SEAL WIDTH	MATERIAL SUPPLY
C1000	CNC SEALING GLUE MACHINE	4' X 8'	9mm - 40mm	TWO COMPONENTS
C1000s	CNC SEALING GLUE MACHINE	4' X 8'	9mm - 40mm	THREE COMPONENTS
M800	MICROSCALE SEALING GLUE MACHINE	600mm x 800mm	2mm - 8mm	TWO COMPONENTS
M800s	MICROSCALE SEALING GLUE MACHINE	600mm x 800mm	2mm - 8mm	THREE COMPONENTS

## INTELLIGENT CNC SEAL GLUING MACHINE

These machines applied all self-developed systems, digital control panel, responsive, and stable operation. The system interfaces with USB port which supports for mobile storage devices. The intelligent operation and simulation function helps preventing processing errors; the intelligent fault alarm functions prevents equipment damage during machine from unseen machine fault; the intelligent low pressure alarm function helps to eliminate products failure due to pressure instability.

### FEATURES :

- ✓ SIMPLE OPERATION, GREAT SAVING ON COST AND TIME
- ✓ EFFICIENT PRODUCTIVITY TO FULFIL MARKET DEMAND
- ✓ WATER AS CLEANING MEDIA, LOW COST AND FRIENDLY TO ENVIRONMENT
- ✓ HUMAN FRIENDLY INTERFACE, EASY MONITOR PARAMETER FOR AIR PRESSURE, LIQUID LEVEL, ETC.

## C1000 PU dispensing machine main technical parameter

Items	Parameter	Remark
X x Y x Z	2440 x 1250 x 150 (mm)	
Weight	1.6 Tons	
Meter precision	± 0.02%	
Work pressure limit and alarm alert	0 - 4 MPA	
Capacity of the material spray	0.3 - 5 g/s	
Gasket strip width	9 - 40 mm	
Range for mixing ratio	1 : 1 - 10 : 1	Calculate it by system
Running speed	0 - 30 m/min	
Precision for reset of dosing head	± 0.05 mm	
Pressure require	≥ 0.6 MPA	
Whole Power	4 - 5 KW	
Frequency	50HZ	
Voltage	3 phases 5 lines 380V	

### MACHINE DIMENSIONS

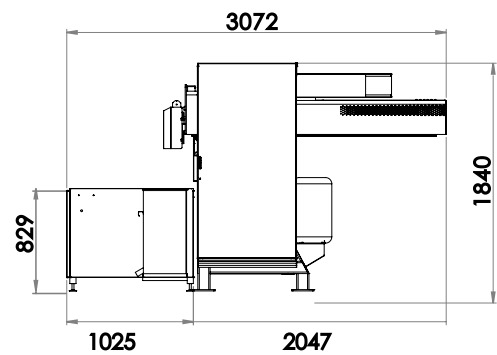
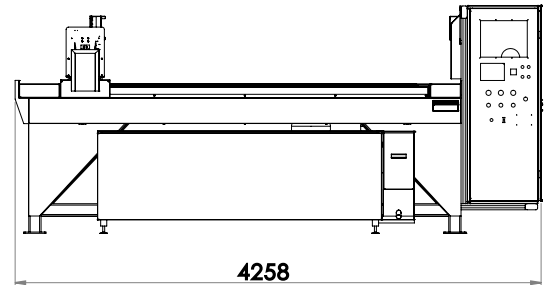

## M800 PU dispensing machine main technical parameter

Items	Parameter	Remark
X x Y x Z	600 x 800 x 150 (mm)	
Weight	950 kg	
Meter precision	± 0.02%	
Work pressure limit and alarm alert	0 - 4 MPA	
Capacity of the material spray	0.3 - 5 g/s	
Gasket strip width	2 - 8 mm	
Range for mixing ratio	1 : 1 - 10 : 1	Calculate it by system
Running speed	0 - 30 m/min	
Precision for reset of dosing head	± 0.05 mm	
Pressure require	≥ 0.6 MPA	
Whole Power	4 - 5 KW	
Frequency	50HZ	
Voltage	3 phases 5 lines 380V	

### MACHINE DIMENSIONS

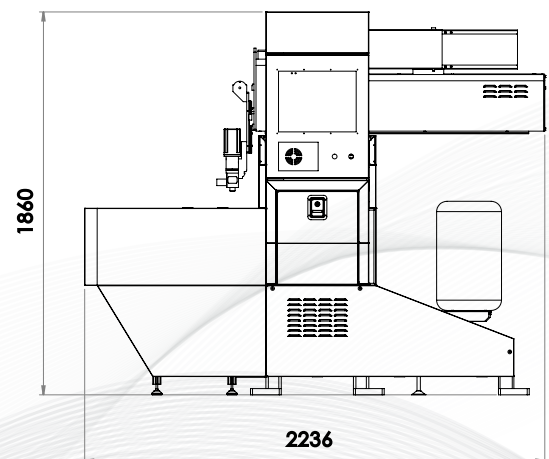
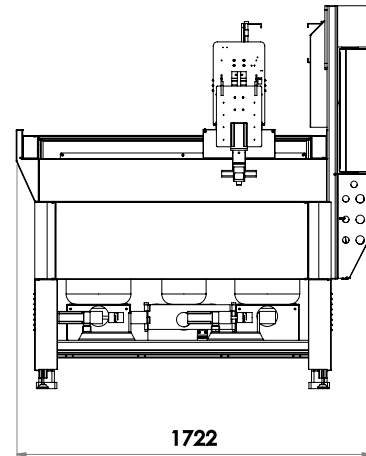

## SMART REFILL GLUE SYSTEM (200L) WITH PUMP



**Automatic Refilling System  
( Pump Transfer )**

Component A is applicable for raw material packed in 200L metal barrel, which can avoid the damage on the glue tape quality caused by the stratification of component A.

The operation of component A feeding is simple.





- Friendly human interface.
- USB port available for portable programmes transfer.
- Pre-programmed template to simplify programmes setting.
- Simulation function to avoid programmes errors.

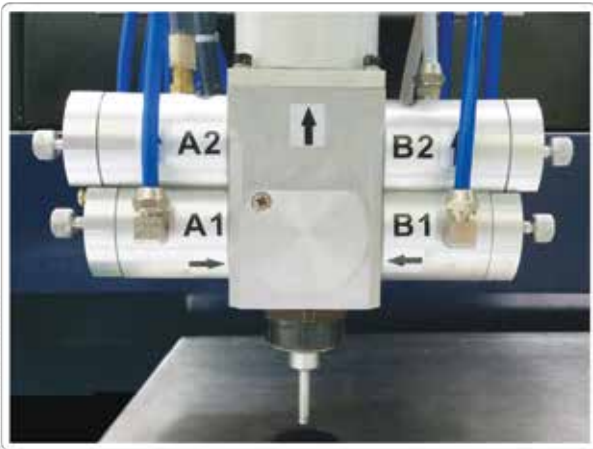

- Self-developed mixing head, output accuracy : 0.1 g/s.
- Auto cleaning after each working cycle.
- Environment friendly, use water as cleaning media.





- 40L A and B resin tank.
- With auto resin low level alarm.
- Auto stirring to keep polymer condition even.
- Auto air-supply to retain component A chemical structure stable.



- Independent human interface to monitor parameter, resin level, liquid level, etc.
- Display of components working pressure, make material feeding convenience.



- Cooling System.

## BALL SCREW WORKING MECHANISM

ABBA Taiwan ball screw is mechanical linear actuator that translates rotational motion to linear motion with little friction.

It provides high reliability, high rigidity and preload, high durability, smooth operation and circulation method.

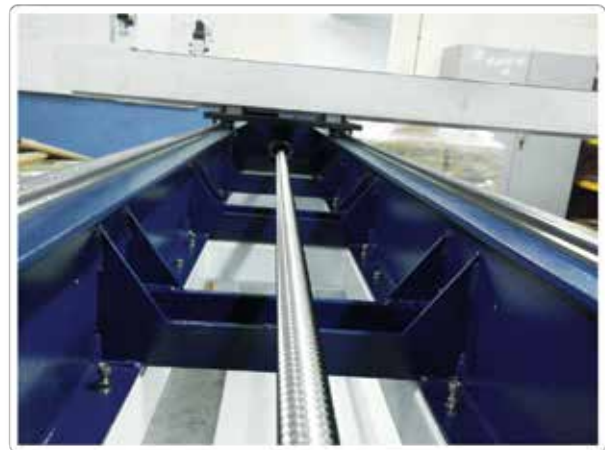

## PUMP SYSTEM

Germany pump system is simple operating principle with a compact and reliable design.

- High efficiency
- Easily serviceable
- Low maintenance

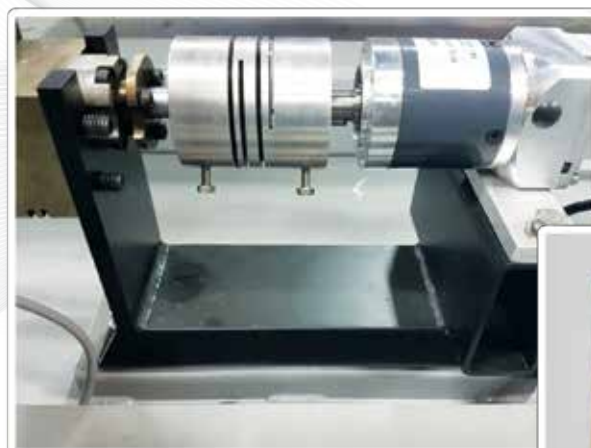







[www.tng-irc.com.my](http://www.tng-irc.com.my)

## **IRC AUTOMATION (M) SDN BHD** (1195989-D)

No 4, Jalan Tiram Sejahtera 3, Taman Perindustrian Tiram Sejahtera,  
81800 Ulu Tiram, Johor, Malaysia.

Tel : 607-8620288 / 607-8620866

Fax : 607-8620087

Email : [info@tng-irc.com.my](mailto:info@tng-irc.com.my)

KL Branch:

No 37, Jalan TK 5/39, Kinrara Industrial Park,  
47100 Puchong, Selangor, Malaysia

### **OUR DISTRIBUTORS**

Vietnam Distributor : **IRC AUTOMATION CO. , LTD.**

Lot B10 Road No. 1, Hai Son Industrial Park (Expansion phase 3 + 4),  
Binh Dien 2 hamlet, Duc Hoa Ha ward, Duc Hoa District, Long An Province

Tel : +84902350025

Email : [thao@tng-irc.com.my](mailto:thao@tng-irc.com.my)

Thailand Distributor : **MAXMACHI CO. , LTD.**

1399/12 Moo 6 Thepharak Rd, Thepharak, Muang Samut Prakam Samutprakam 10270.

Tel : +6623851988

Fax : +6623851989

Email : [engineer@maxmachi.co.th](mailto:engineer@maxmachi.co.th) / [peratum@yahoo.com](mailto:peratum@yahoo.com)

Indonesia Distributor : **PT. ELEMEN GEMILANG SURYAMASINKA**

### **JAKARTA OFFICE**

Perkantoran Citi Square Business Park Blok G No. 8 Jl. Peta Selatan, Kalideres Jakarta Barat 11840

Tel: +62 212205 2042

### **SURABAYA OFFICE**

Pertokoan RMI Blok K16 Jl. Ngagel Jaya Selatan Surabaya 60284

Tel : +62 31503 9586

Email : [sales@suryamasinka.com](mailto:sales@suryamasinka.com)





**IRC AUTOMATION (M) SDN BHD**  
(1195989-D)

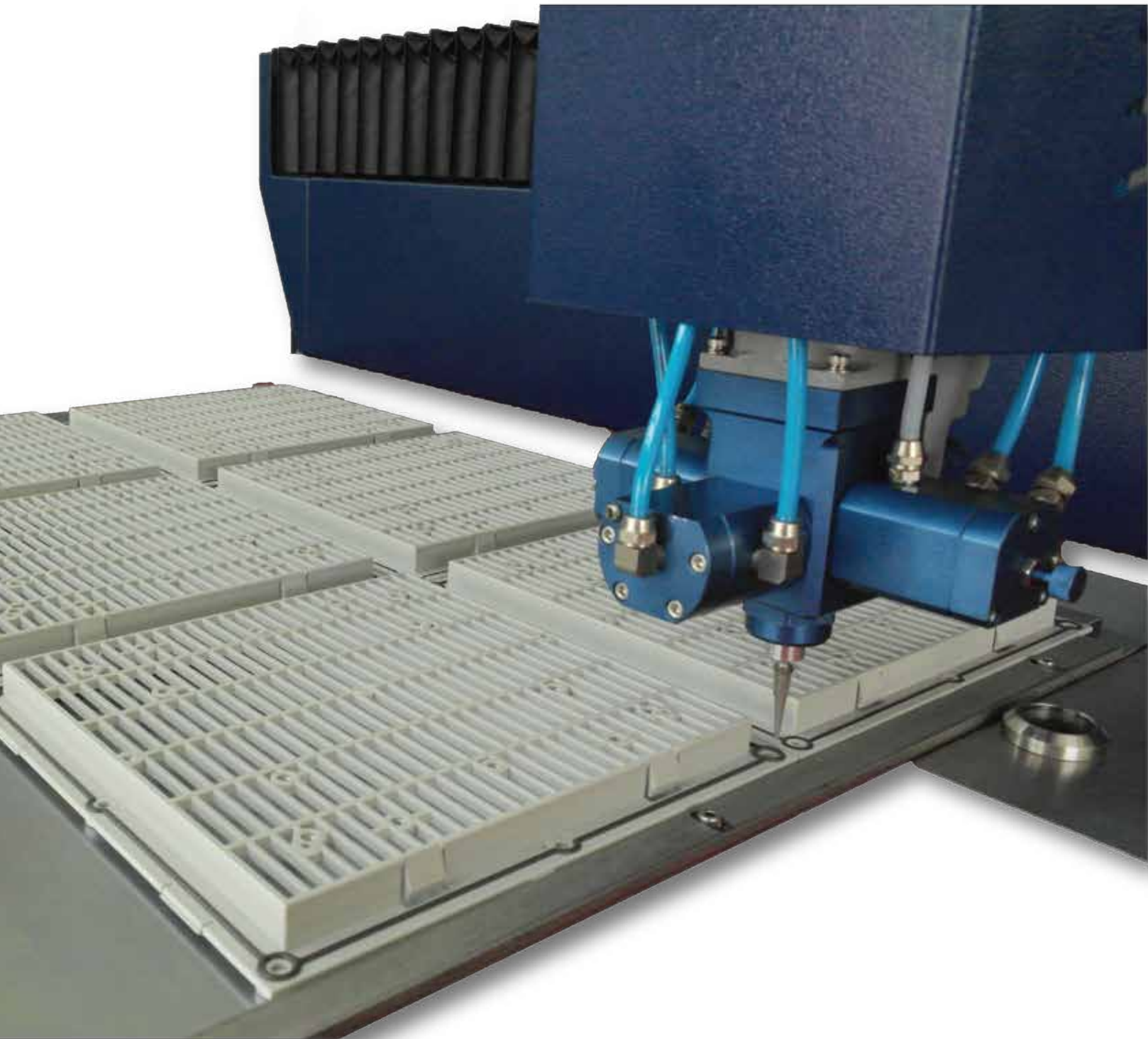

**AUTO SEAL GLUING MACHINE**  
SOLUTION FOR ENCLOSURE SEALING